

Rudolph F. Crew, Ed.D., Superintendent of Schools

**SUBJECT: REQUEST FOR APPROVAL OF SUPERINTENDENT'S
REORGANIZATION AND RESTRUCTURING OF SELECTED DISTRICT
OFFICES**

- 1. APPROVE THE PROPOSED REORGANIZATION AND RESTRUCTURING OF SELECTED DISTRICT OFFICES**
- 2. DELETE MANAGERIAL EXEMPT AND CONTRACTED POSITIONS**
- 3. RECLASSIFICATION OF MANAGERIAL EXEMPT POSITION**
- 4. ESTABLISH AND CLASSIFY NEW MANAGERIAL EXEMPT POSITIONS**
- 5. APPOINT AND ASSIGN ADMINISTRATIVE PERSONNEL**
- 6. CHANGE OF TITLE**
- 7. RECEIVE ORGANIZATIONAL CHARTS**
- 8. AUTHORIZE THE SUPERINTENDENT TO MAKE MINOR PERSONNEL ADJUSTMENTS IN THE REORGANIZATION, IF NECESSARY, AND REPORT IN WRITING TO THE BOARD**

**COMMITTEE: LEGISLATIVE RELATIONS, PUBLIC RELATIONS AND PERSONNEL
SERVICES**

Authorization of the Board is requested to approve the Superintendent's reorganization and restructuring of selected District offices. In accordance with Florida Statute Sections 1001.42 and 1012.22, and School Board Rule 6Gx13- 4A-1.15, it is within the Superintendent's authority to recommend a reorganization involving personnel and offices within the District and then submit this recommended reorganization and restructuring to the Board for approval. The School Board approved phase one of my reorganization and restructuring of selected District offices at the July 14, 2004 Board meeting.

As a result of my ongoing review of District operations and functions I am proposing phase two of my reorganization and restructuring. The purpose of this reorganization and restructuring is to implement an organizational model that better designates functions, emphasizes efficiency in operations and communication and streamlines the administrative organization of the District. A critical item of this organization and restructuring are school site administrative personnel changes resulting from the formation of the "School Improvement Zone" (SIZ) initiative. As such, there will be on-going recommendations to the Board based on further analysis of District needs, efficiency and financial issues.

The proposed phase two of my reorganization and restructuring reflects the District's strategic plan, as well as my priorities: To improve low performing schools, address finance, construction and budget issues, and enhance the District's focus on curriculum and instruction.

As in phase one of my reorganization and restructuring, the overriding criteria and objectives of this reorganization are as follows:

1. The organizational structure focuses on education as the primary mission of the District.
2. A major focus within the area of education is on the Superintendent's School Improvement Zone which provides oversight of state monitored and other designated schools requiring specialized educational services. Although it is the primary focus of the Deputy Superintendent, School Improvement to accomplish this critical task, the Deputy Superintendents for Curriculum and Instruction, Business, Operations, Finance, and Construction, and Professional Development will also assist with this task.
3. The structure substantially improves management and accountability for the efficient and effective business infrastructure of the District by consolidating the business, operations, finance and construction functions under one deputy superintendent.
4. The reorganization facilitates and enhances the District's strategic plan supporting the goals of effective learning environment, efficient management practices, and school to career.

Following is a summary of the reporting lines for the various members of my cabinet:

DEPUTY SUPERINTENDENT, SCHOOL IMPROVEMENT – I am appointing Dr. Irving S. Hamer, Jr., Chief of Staff (Interim) to the position of Deputy Superintendent, School Improvement. The Deputy Superintendent, School Improvement, is responsible for the oversight of the Superintendent's School Improvement Zone and will supervise Instructional Support Elementary and Instructional Support Secondary.

DEPUTY SUPERINTENDENT, CURRICULUM AND INSTRUCTION – The Deputy Superintendent, Curriculum and Instruction will incorporate Instructional Technology. The Deputy will continue to supervise the Area Community Center for Educational Support Services (ACCESS), Management Operations, Curriculum Development and Instructional Support, Library Media and Instructional Materials Services, and the Office of Adult/Vocational, Alternative and Community Education. The operations of the schools relative to Adult/Vocational, Alternative and Community Education will reside with the ACCESS Centers. The curriculum development and special services will remain with the Office of Adult/Vocational, Alternative, and Community Education.

DEPUTY SUPERINTENDENT, BUSINESS, OPERATIONS, FINANCE, AND CONSTRUCTION - The Deputy Superintendent, Business, Operations, Finance, and Construction will incorporate various offices under her administrative supervision, inclusive of Safety, Energy Communications and Fiscal Management; Facilities Compliance; Office of Business Operations Performance Improvement, and M/WBE and Related Services. The Deputy will continue to supervise Construction, Maintenance and Facilities, Office of Transportation, Office of Information Technology, Office of Food and Nutrition and Financial Operations. I am appointing Ms. Rose Diamond, as Chief Facilities Maintenance, Construction Officer to head the Construction, Maintenance and Facilities operations.

DEPUTY SUPERINTENDENT, PROFESSIONAL DEVELOPMENT – The Deputy Superintendent, Professional Development will implement the overall Districtwide efforts regarding professional development in support of the School Improvement Zone as well as the District's goals of effective learning environment, efficient management practices, and

school to career. In order to more efficiently align the professional development functions, the Deputy will incorporate Teacher Education and Leadership Development under his/her supervision. This position is currently open.

CHIEF COMMUNICATIONS OFFICER – The Chief Communications Officer will supervise the following departments: Marketing, Citizen’s Information, Media Programs and WLRN, Public Relations and Media Relations.

CHIEF OF ACCOUNTABILITY AND SYSTEMWIDE PERFORMANCE – This position is still open but I have determined that the Chief will supervise the Office of Research and Assessment and Data Analysis.

CHIEF PERSONNEL OFFICER – The Chief Personnel Officer will incorporate the Office of Professional Standards, Risks and Benefits Management and Civil Rights and Diversity Compliance. The Chief Personnel Officer will continue to supervise Personnel Employment and Staffing, Personnel Support Programs, Compensation Administration, and the Office of Labor Relations.

CHIEF OF STAFF – The Chief of Staff will incorporate three offices under her supervision, that is, Program Evaluation, Strategic Planning and Office of Management and Compliance Audits.

CHIEF OF POLICE AND DISTRICT SECURITY – The Chief of Police and District Security will continue to supervise the Professional Compliance Unit, Police Information Officer, the Office of the Assistant Chief of Police, Special Projects, and Police Accreditation.

ASSOCIATE SUPERINTENDENT, INTERGOVERNMENTAL AFFAIRS AND GRANTS ADMINISTRATION - I am proposing to reclassify the position of Assistant Superintendent, Intergovernmental Affairs and Grants Administration, MEP pay grade 25 to Associate Superintendent, Intergovernmental Affairs and Grants Administration, MEP pay grade 26 and appoint Mr. Alberto Carvalho. This action will bring this position in alignment with the rest of my direct reports at the Chief level. The Associate Superintendent will incorporate Title 1 Administration under his supervision and will continue to supervise the functions of Intergovernmental Affairs and Grants Administration.

DEVELOPMENT OFFICER - The Development Officer will incorporate the Office of Community Services and the Office of Parental Involvement under his/her supervision. This position is currently open. } Revised

RECOMMENDED: That The School Board of Miami-Dade County, Florida, do the following:

1. Approve the proposed reorganization and restructuring of selected district offices;
2. Delete the following Managerial Exempt and Contracted Positions:

- a. Deputy Superintendent of Schools, MEP pay grade 28;
- b. Facilities Maintenance Officer, MEP pay grade 26; and
- c. Facilities Construction Officer, MEP pay grade 26

3. Reclassify the following Managerial Exempt Position:

Assistant Superintendent, Office of Intergovernmental Affairs and Grants Administration, MEP pay grade 25, to Associate Superintendent, Office of Intergovernmental Affairs and Grants Administration, MEP pay grade 26

4. Establish and classify the following administrative positions:

- a. Deputy Superintendent, Professional Development, MEP pay grade 28
- b. Chief Facilities Maintenance and Construction Officer, MEP pay grade 26

5. Appoint and assign administrative personnel effective August 18, 2004, or as soon thereafter as can be facilitated with the exception of the effective dates as noted in the item:

- a. Irving S. Hamer, Jr., Chief of Staff (Interim), MEP pay grade 26, to Deputy Superintendent, School Improvement, MEP pay grade 28, effective July 26, 2004;
- b. Rose Diamond, to Chief Facilities Maintenance and Construction Officer, MEP pay grade 26, effective upon completion of background check; and
- c. Alberto M. Carvalho, Assistant Superintendent, Office of Intergovernmental Affairs and Grants Administration, MEP pay grade 25, to Associate Superintendent, Office of Intergovernmental Affairs and Grants Administration, MEP pay grade 26
- d. Barbara M. George, Principal, Thena C. Crowder Elementary School, MEP pay grade 22, to Assistant Principal, Hialeah Elementary School, MEP pay grade AP, effective August 13, 2004
- e. Edith N. Norniella, Principal, Lakeview Elementary School, MEP pay grade 22, to Assistant Principal, M. A. Milam K-8 Center, MEP pay grade AP, effective August 13, 2004
- f. Gloria P. Barnes, Principal, Little River Elementary School, MEP pay grade 22, to Assistant Principal, Fulford Elementary School, MEP pay grade AP, effective August 13, 2004
- g. Annie H. Ingraham, Principal, Norland Elementary School, MEP pay grade 22, to Assistant Principal, Palmetto Elementary School, MEP pay grade AP, effective August 13, 2004

} Revised

- h. Mary S. Jackson-Johnson, Principal, Santa Clara Elementary School, MEP pay grade 22, to Assistant Principal on Special Assignment, ACCESS Center 4, MEP pay grade AP, effective August 13, 2004
- i. Orlando B. Milligan, Principal, Brownsville Middle School, MEP pay grade 22, to Principal, Juvenile Justice Center, MEP pay grade 22, effective August 13, 2004
- j. Gloria F. Evans, Principal, Booker T. Washington Senior High School, MEP pay grade 23, to Principal, Miami Dorsey Skill Center, MEP pay grade 22, effective August 13, 2004
- k. Gigi M. Gilbert, Principal, Dr. H. W. Mack/West Little River Elementary School, pay grade 22, to Assistant Principal, Irving & Beatrice Peskoe Elementary School, MEP pay grade AP, effective August 13, 2004
- l. Dahlia M. Gonzalez, Assistant Principal, Palmetto Elementary School, MEP pay grade AP, to Principal, Thena C. Crowder Elementary School, MEP pay grade 22, effective August 13, 2004
- m. Jeffrey Hernandez, Assistant Principal, M. A. Milam K-8 Center, to Principal, Lakeview Elementary School, MEP pay grade 22, effective August 13, 2004
- n. Isabel D. Castillo, Assistant Principal, Mae Walters Elementary School, MEP pay grade AP, to Principal, Little River Elementary School, MEP pay grade 22, effective August 13, 2004
- o. Karen S. Powers, Assistant Principal, Fulford Elementary School, MEP pay grade AP, to Principal, Norland Elementary School, MEP pay grade 22, effective August 13, 2004
- p. Marie P. Caceres, Assistant Principal, Hialeah Middle School, MEP pay grade AP, to Principal, Santa Clara Elementary School, MEP pay grade 22, effective August 13, 2004
- q. Guillermo A. Munoz, Assistant Principal, Miami Northwestern Senior High School, MEP pay grade AP to Principal, Brownsville Middle School, MEP pay grade 22, effective August 13, 2004
- r. Rosann P. Sidener, Assistant Principal, Miami Senior High School, MEP pay grade AP, to Principal, Booker T. Washington Senior High School, MEP pay grade 23, effective August 13, 2004
- s. Elisa L. Perez, Assistant Principal, Hialeah Elementary School, MEP pay grade AP, to Principal, Martin L. King K-2 Elementary School, MEP pay grade 22, effective August 13, 2004
- t. Reva A. Vangates, Principal, Martin L. King K-2 Elementary School, MEP pay grade 22, to Principal, Dr. H. W. Mack/West Little River Elementary School, MEP pay grade 22, effective July 20, 2004

} Revised

6. Change of title

Assistant Superintendent, Elementary and Secondary Education, MEP pay grade 25, to Assistant Superintendent, Instructional Support (Elementary/Secondary), MEP pay grade 25

7. Receive the Organizational Charts
8. Authorize the Superintendent to make minor personnel adjustments in the reorganization, if necessary, and report in writing to the Board.

Direct Reports to the Superintendent of Schools

Superintendent of Schools
Dr. Rudolph F. Crew

Development Officer
 OPEN [24]

Administrative Assistant
 C. Sandoval [20]

Administrative Assistant
 OPEN [22]

Management Projects Admin. Assistant
 G. Byrd [20]

Business, Operations, Finance, and Construction
 Deputy Superintendent
 O. San Pedro [28]

Chief of Staff
 C. Spatt [26]

Chief of Police & District Security
 G. Darling [26]

Intergovernmental Affairs & Grants Administration
 Assoc. Superintendent
 A. Carvalho [26]

School Improvement
 Deputy Superintendent
 I. Hamer [28]

Chief Personnel Officer
 H. James [26]

Curriculum and Instruction
 Deputy Superintendent
 M. Toural [28]

Chief of Communications
 J. Smith [26]

Chief of Accountability and Systemwide Performance
 OPEN [26]



Business, Operations, Finance, and Construction

Superintendent
of Schools
Dr. Rudolph F. Crew

Business, Operations,
Finance, and Construction
Deputy Superintendent
O. Sam Pedro, [28]

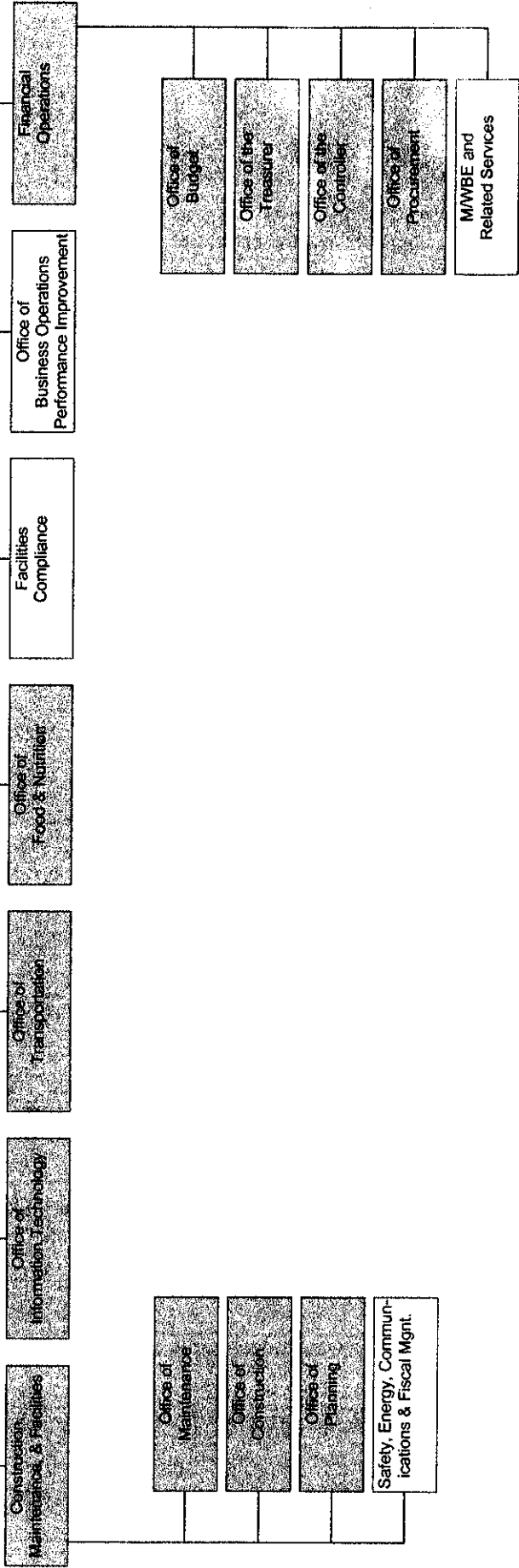

Note: Unshaded boxes represent offices/divisions that were previously under a different department.

School Improvement Zone

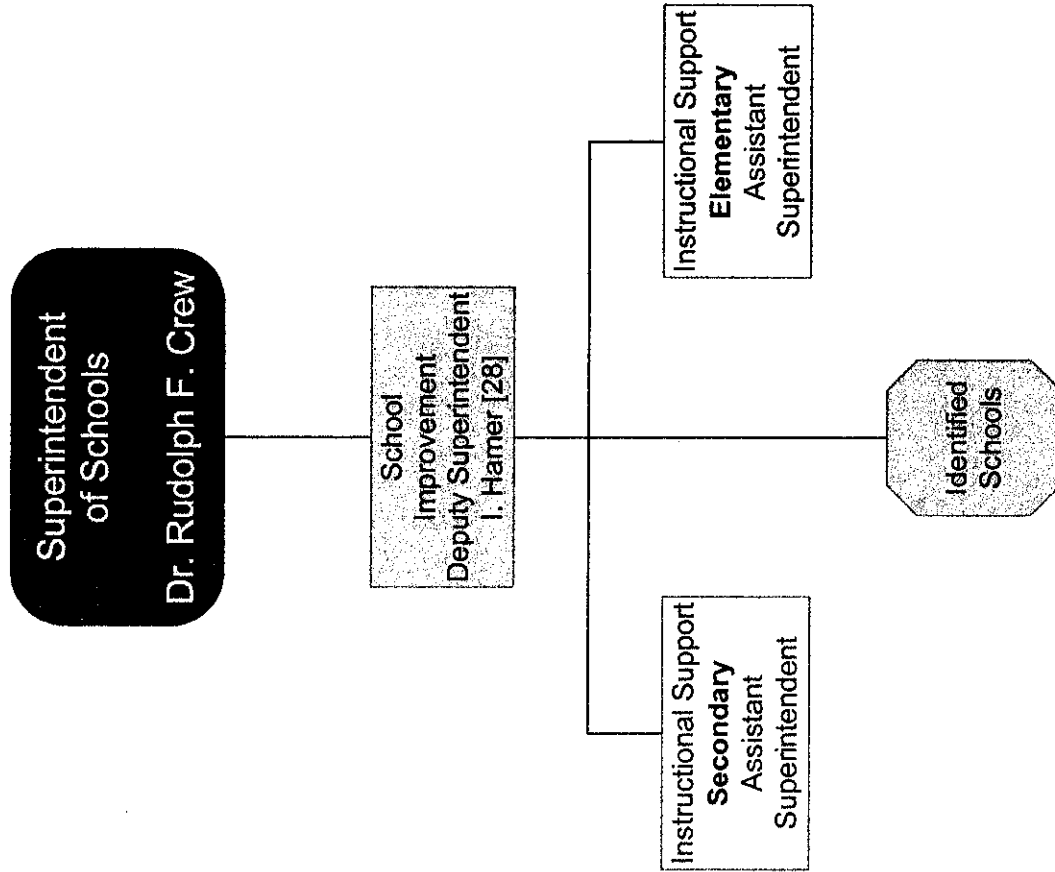

Note: Unshaded boxes represent offices/divisions that were previously under a different department.

Curriculum and Instruction

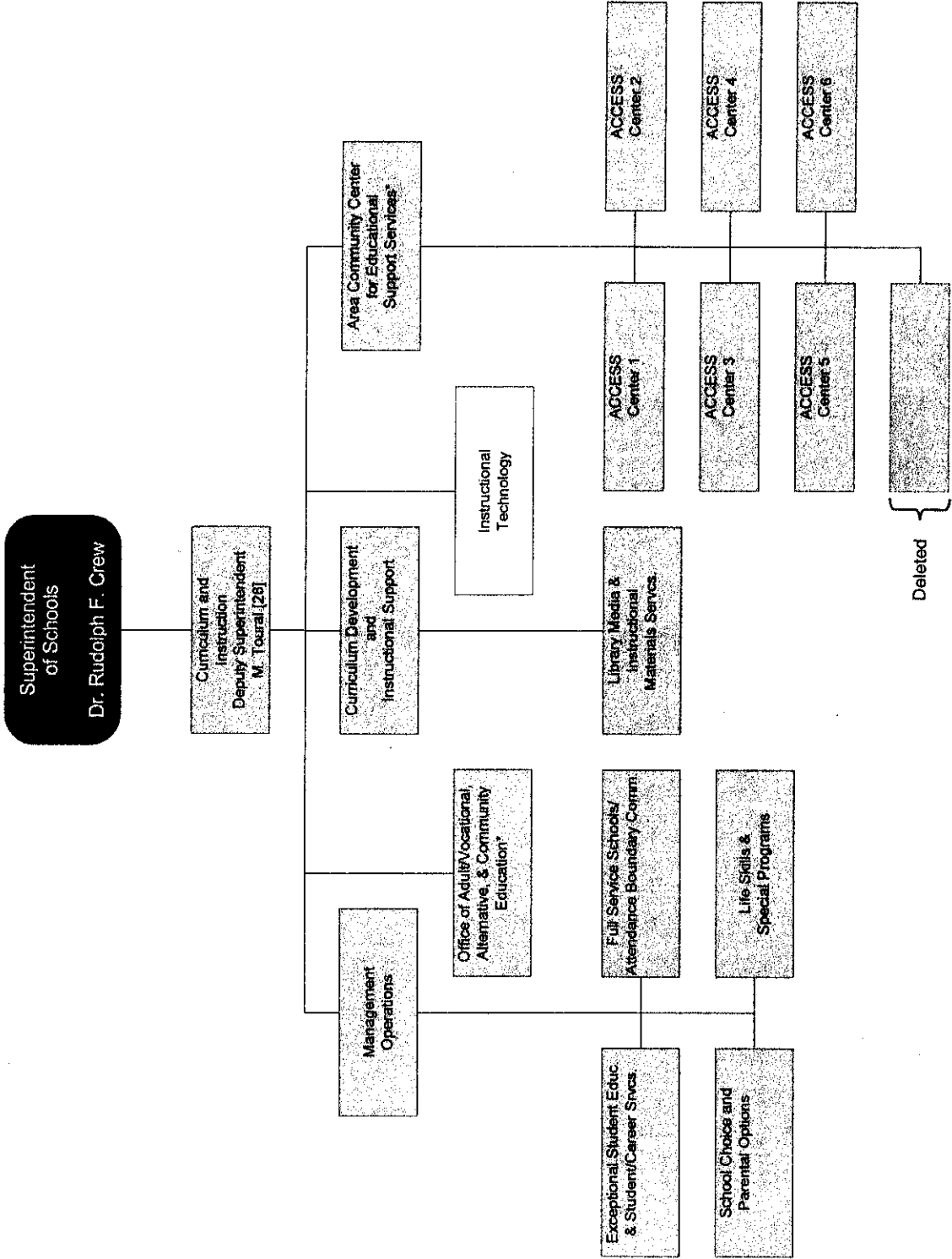

* The operation of these schools will now be part of the ACCESS Centers. The curriculum development and special services will remain separate.

Professional Development

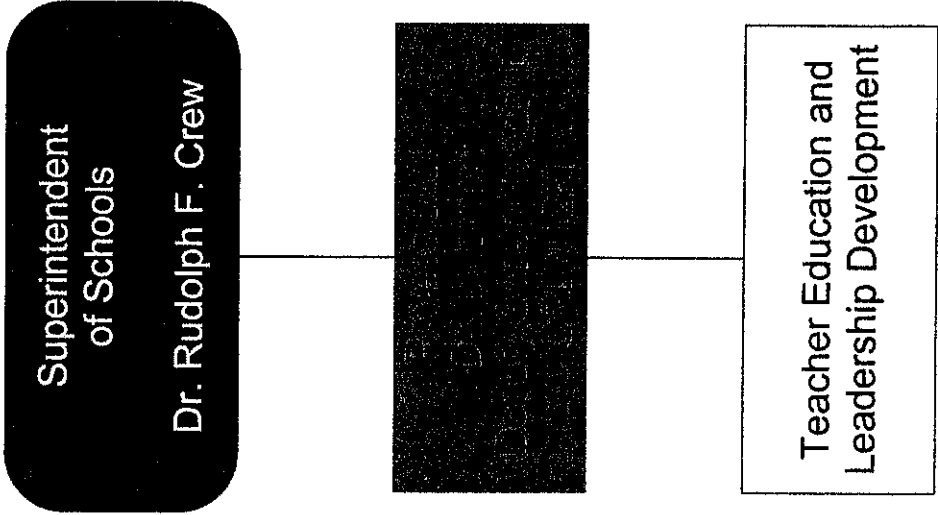

Note: Unshaded boxes represent offices/divisions that were previously under a different department.

Office of Community Services

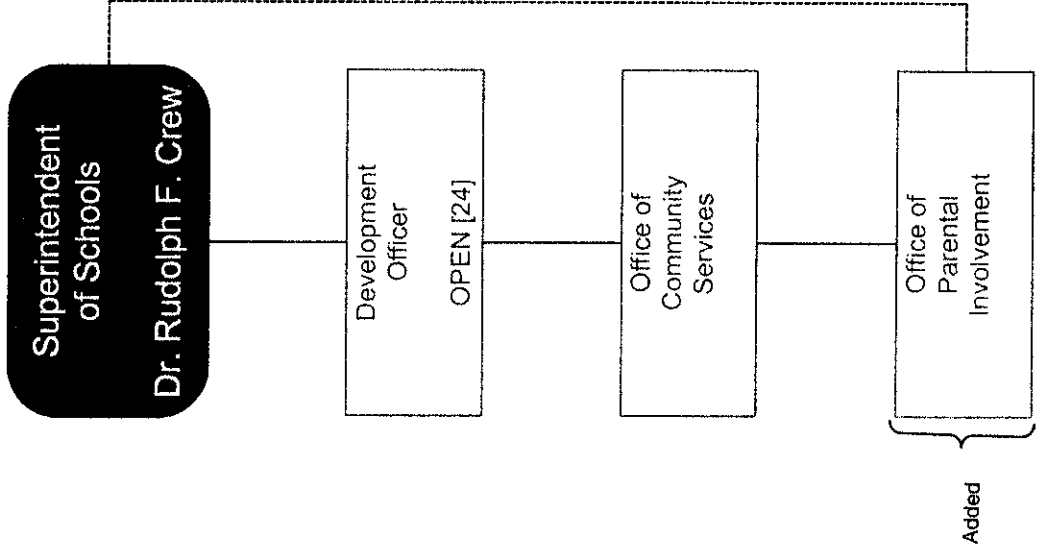

Revised: August 16, 2004

Note: Unshaded boxes represent offices/divisions that were previously under a different department.

Chief of Staff

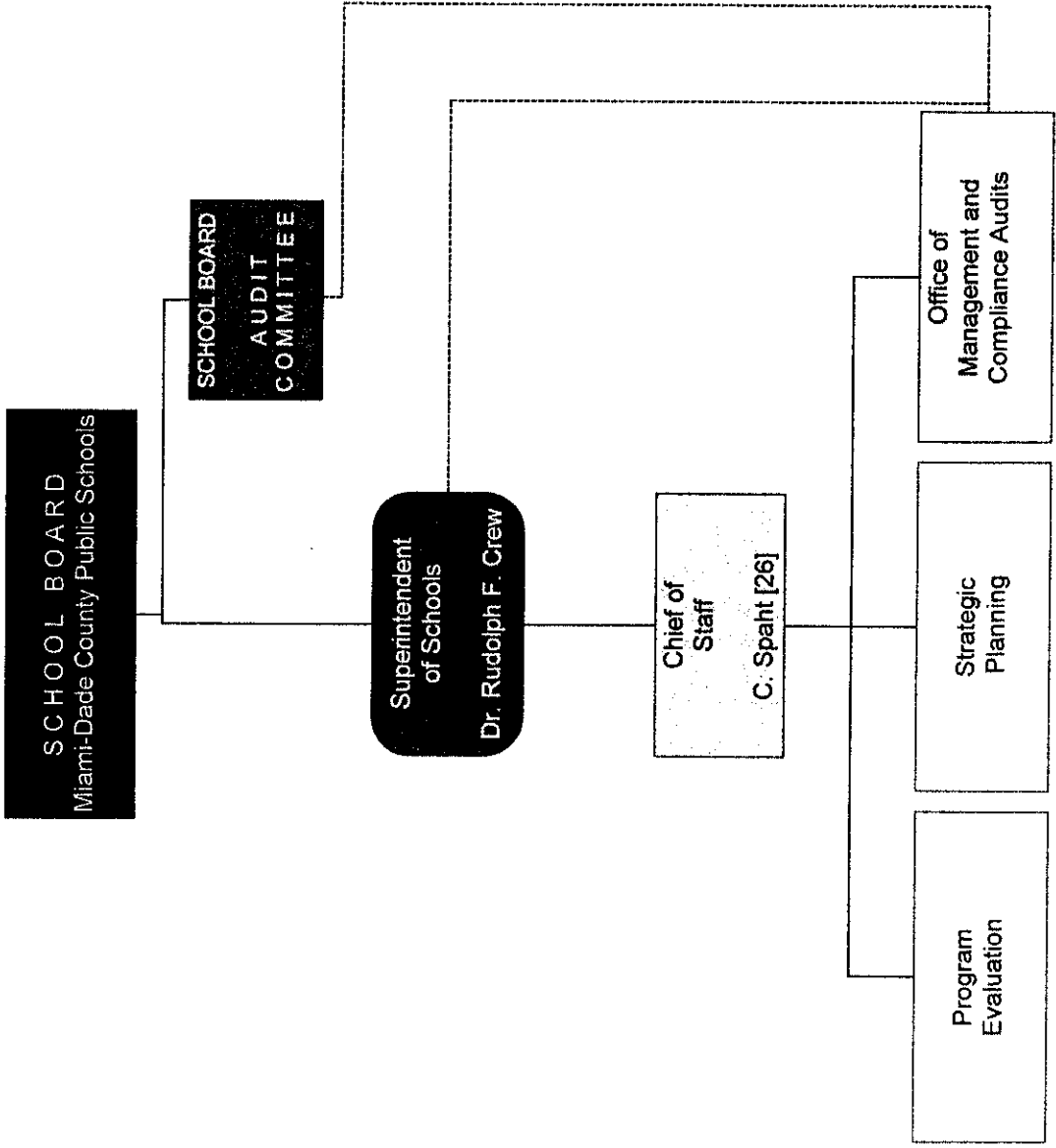

Note: Unshaded boxes represent offices/divisions that were previously under a different department.

Police and District Security

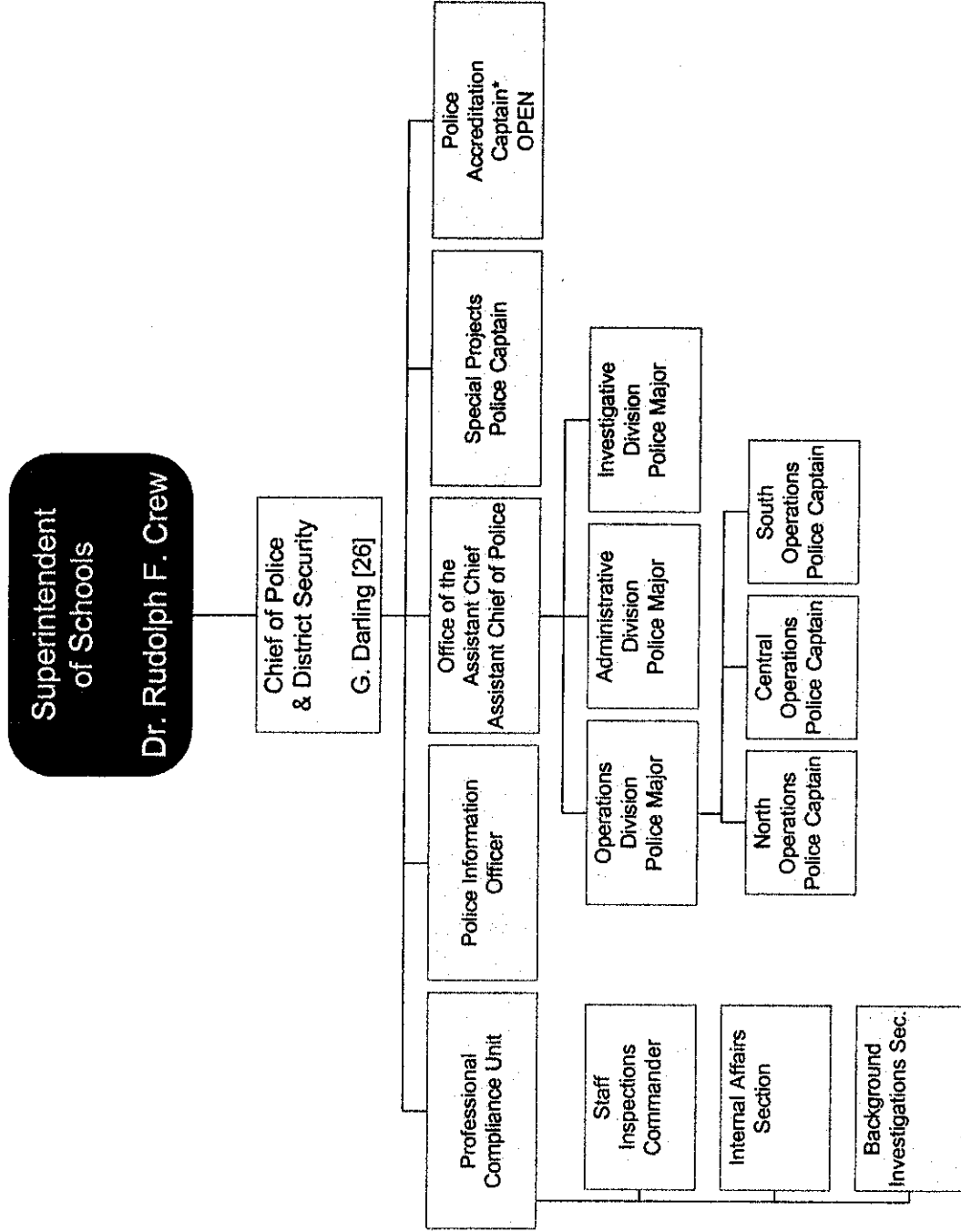

*Position has been approved by the School Board but is yet to be filled.

Intergovernmental Affairs and Grants Administration

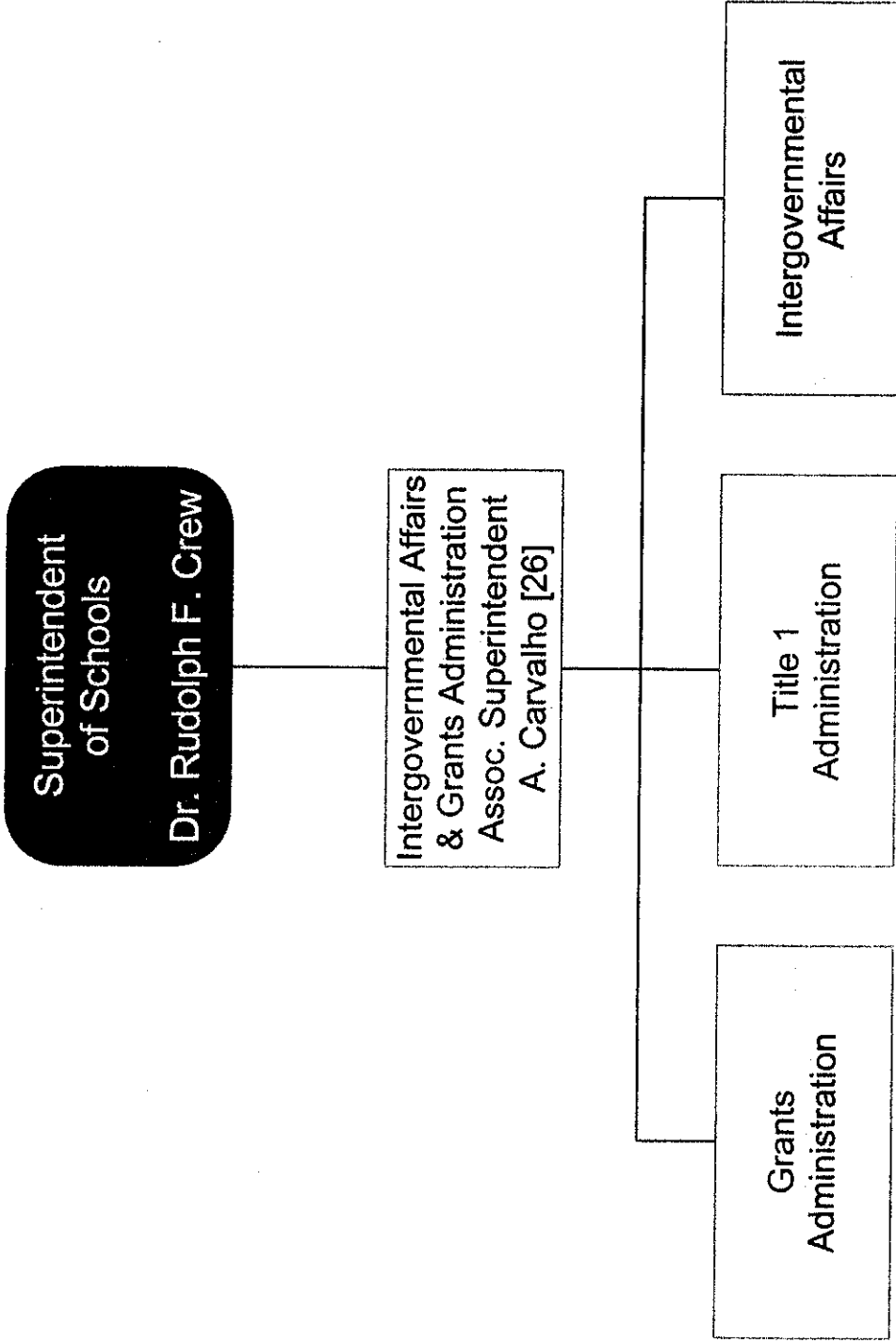

Note: Unshaded boxes represent offices/divisions that were previously under a different department.

Human Resources

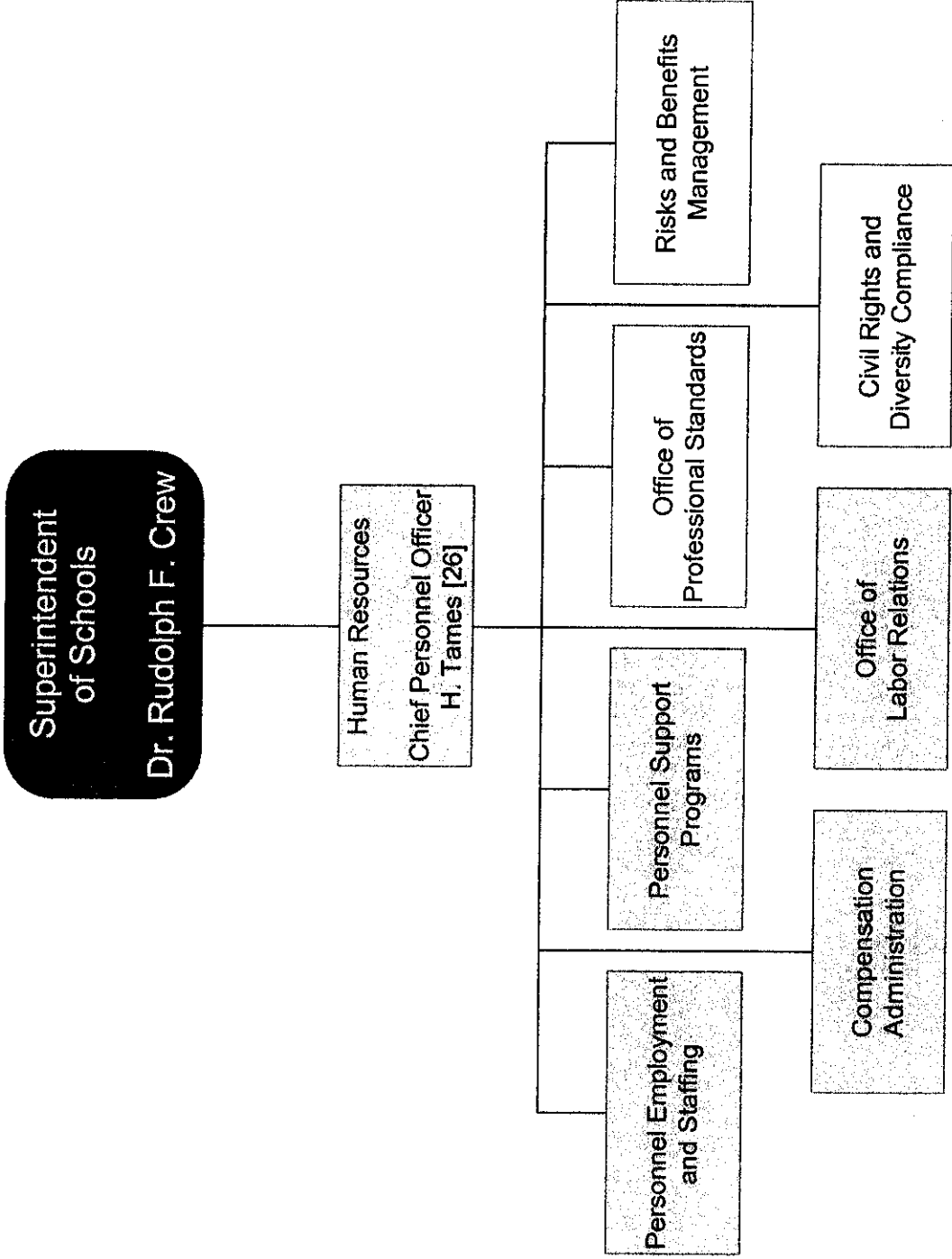

Note: Unshaded boxes represent offices/divisions that were previously under a different department.

Communications

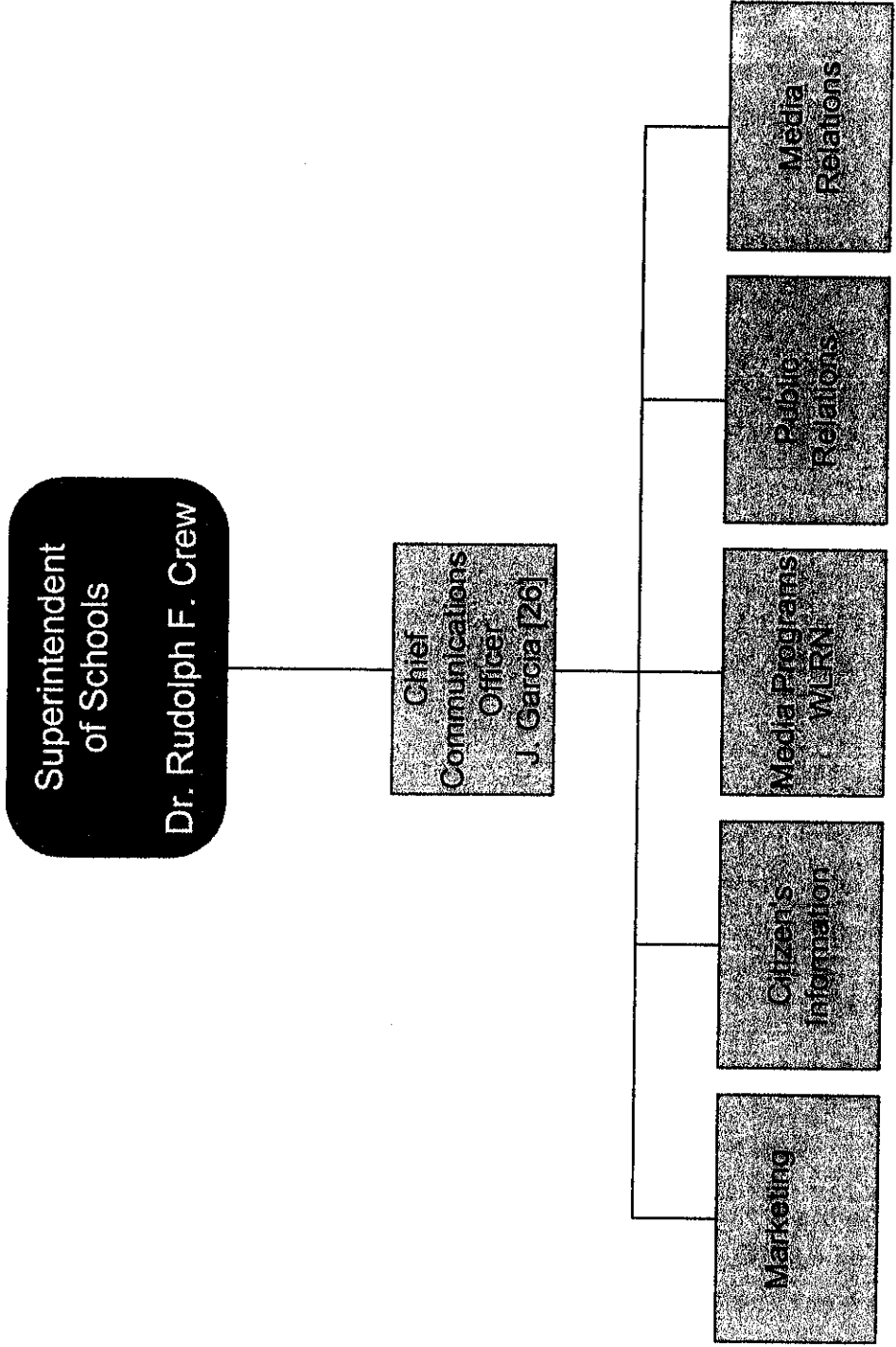

Accountability and Systemwide Performance

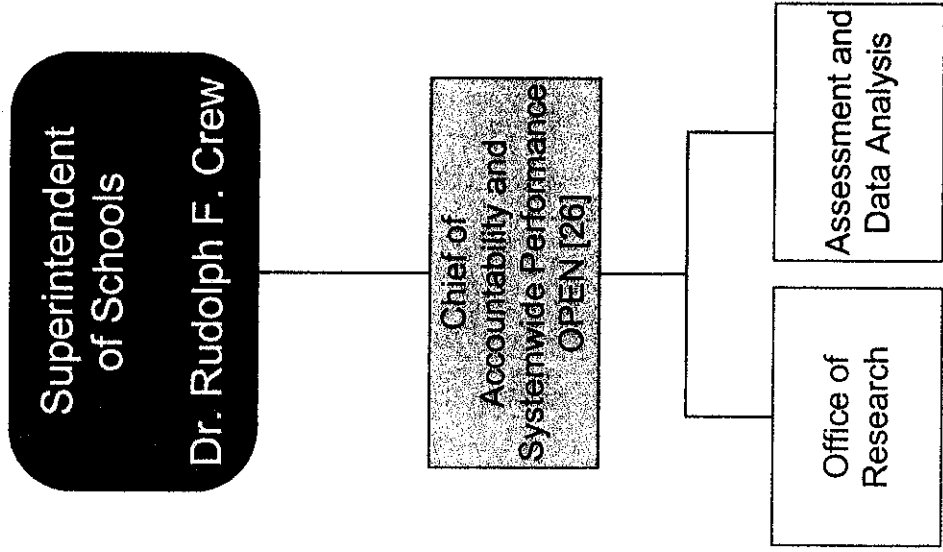

Note: Unshaded boxes represent offices/divisions that were previously under a different department.